



Awning enclosure

Installation and usage instructions

EN

Markisenvorzelt

Montage- und Gebrauchsanleitung

DE

Auvent pour stores

Instructions de montage et mode d'emploi

FR

Cierre para toldos

Instrucciones de montaje y uso

ES

Chiusura per tendalini

Istruzioni di montaggio e d'uso

IT

**Please consult the website for
instructions in the languages:**

NL-SV-DA-NO-FI-PT

PRIVACY ROOM

F80s - F65s - F65L



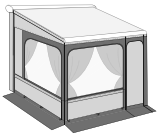

Base Module
[S], [M], [L]

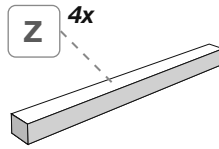
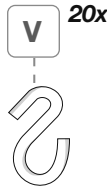
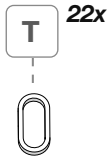
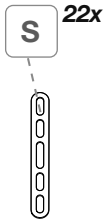
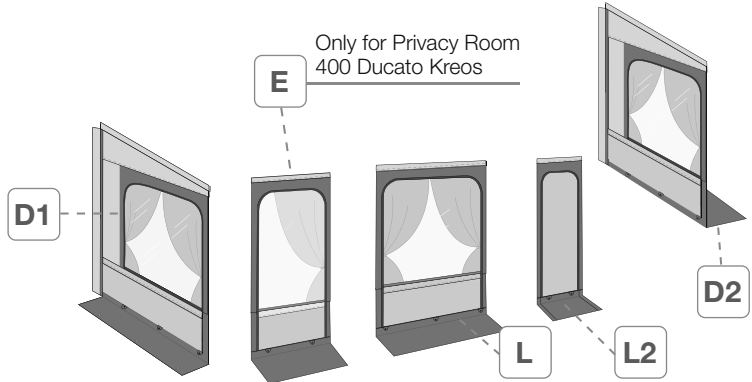

Not for
Privacy Room 300 Ducato

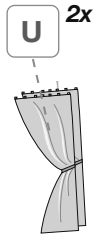

Only for Privacy Room
300 Ducato
Item No. 08760-01-

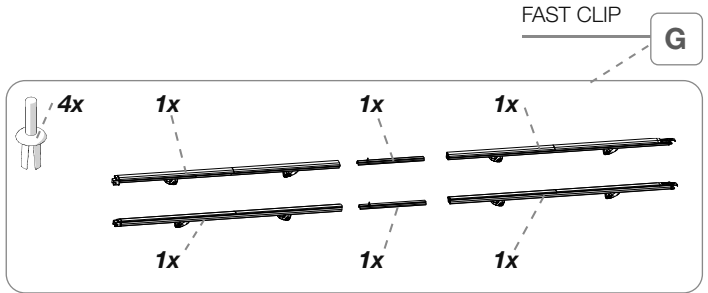
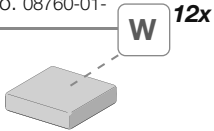

Kit 98661-018
F80s

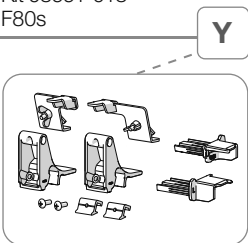

Kit 98655-899
F65

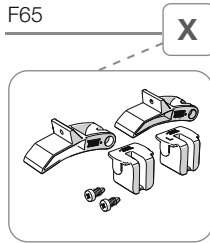

Only for Privacy Room 300 / H 245/280
Privacy Room 400 Ducato Krees

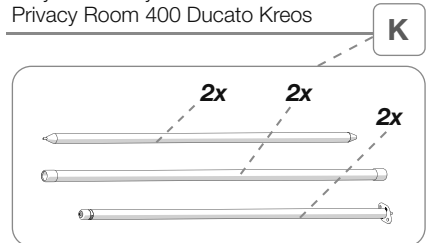

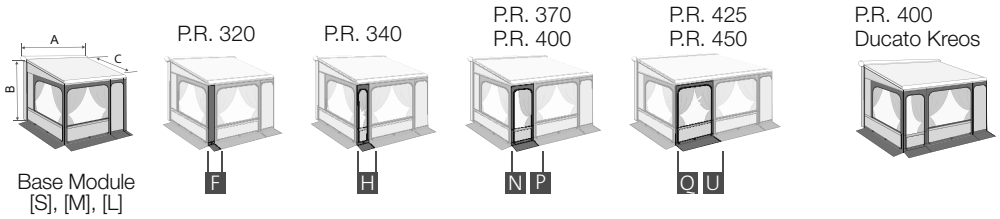

Base Module	Item No.	A	B	C	
P. R. 300 Ducato > 06	* [S] 08760-01-	300 cm	245 cm	250 cm	23,3 kg
P. R. 300 / H 245/280	[M] 08368B01-	300 cm	245-280 cm		23,2 kg
P. R. 300 H3	[L] 08368A01-	300 cm	280 cm		24 kg
P. R. 400 Ducato Kreos	08369-01-	400 cm	300 cm		26 kg

* Complete with Magnet Kit (2 sets of 6 magnets) which, inserted in the side panel pocket, permit complete adhesion to the Ducato vehicle.

Front panels	Item No.
20 cm	[F] 08364-01-
40 cm	[H] 08364A01-
70 cm	[N] 08364C01-
100 cm	[P] 08364E01-
125 cm	[Q] 08364F01-
150 cm	[U] 08364H01-

Description	A	B	Composition
P. R. 300 Ducato >06/06	300 cm	Van [S] 245 cm	[S]
P. R. 320 Ducato >06/06	320 cm		[S] + [F]
P. R. 340 Ducato >06/06	340 cm		[S] + [H]
P. R. 370 Ducato >06/06	370 cm		[S] + [N]
P. R. 400 Ducato >06/06	400 cm		[S] + [P]
P. R. 425 Ducato >06/06	425 cm		[S] + [Q]
P. R. 450 Ducato >06/06	450 cm		[S] + [U]

Description	A	B	Composition
P. R. 300 / H: 245-280	300 cm	Medium [M] 245-280 cm	[M]
P. R. 320 / H: 245-280	320 cm		[M] + [F]
P. R. 340 / H: 245-280	340 cm		[M] + [H]
P. R. 370 / H: 245-280	370 cm		[M] + [N]
P. R. 400 / H: 245-280	400 cm		[M] + [P]
P. R. 425 / H: 245-280	425 cm		[M] + [Q]
P. R. 450 / H: 245-280	425 cm		[M] + [U]
P. Room 300 H3	300 cm	Large [L] 280 cm	[L]
P. Room 320 H3	320 cm		[L] + [F]
P. Room 340 H3	340 cm		[L] + [H]
P. Room 370 H3	370 cm		[L] + [N]
P. Room 400 H3	400 cm		[L] + [P]
P. Room 425 H3	425 cm		[L] + [Q]
P. Room 450 H3	425 cm		[L] + [U]

Package contents / Verpackungsinhalt / Contenu de l'emballage / Contenido del embalaje / Contenuto dell'imballo **p. 2**

Installation instructions / Montageanleitung / Instructions de montage / Instrucciones de montaje / Istruzioni di montaggio **p. 4**

Instructions for use / Gebrauchsanleitung / Instructions d'installation / Instrucciones de uso / Istruzioni di utilizzo **p. 10**

Safety instructions / Sicherheitshinweise / Consignes de sécurité / Instrucciones de seguridad / Avvertenze di sicurezza **p. 12**

Accessories / Zubehör / En option / Accesorios / Accessori **p. 17**

Warranty / Garantie / Garantie / Garantía / Garanzia **p. 18**



EN Check that nothing has been damaged or deformed during transport. In the event of doubts or questions concerning the installation, use or limitations of the product, contact the dealer.

DE Bitte kontrollieren Sie, dass alle Einzelteile einwandfrei sind und nicht während dem Transport beschädigt wurden. Im Zweifelsfall oder bei Fragen zur Montage, Verwendung oder zu Einschränkungen des Produkts wenden Sie sich bitte an Ihren Händler.

FR Contrôler le contenu du colis et vérifier qu'aucune pièce n'ait été cassée ou déformée durant le transport. En cas de doutes ou de questions relatives à l'installation, l'utilisation du produit, contactez votre concessionnaire.

ES Controlar que ningún detalle se haya roto o deformado durante el transporte. En caso de dudas o si tiene alguna pregunta sobre el montaje, uso y limitaciones del producto, póngase en contacto con el distribuidor.

IT Controllare che nessun particolare sia rotto o deformato a causa di errori di trasporto. In caso di dubbi o domande relative al montaggio, utilizzo e limiti del prodotto, contattare il rivenditore.

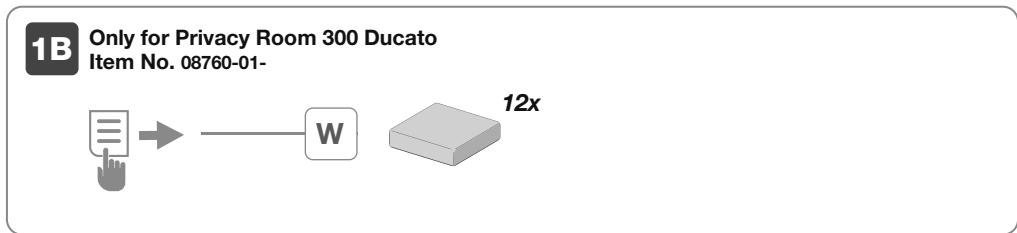
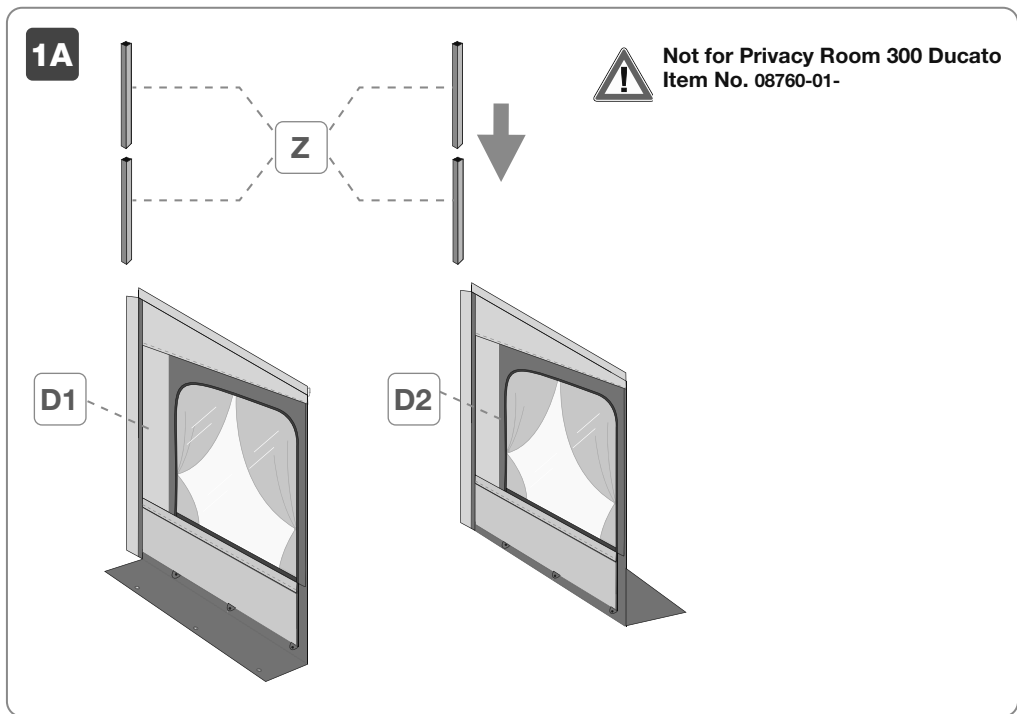



F80s
F65s

2



Fast Clip

G



F80s
KIT 98661-018

Y

F65
KIT 98655-899

X

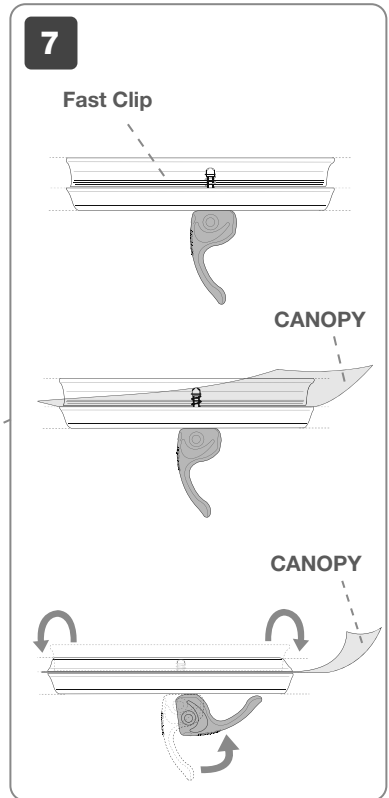
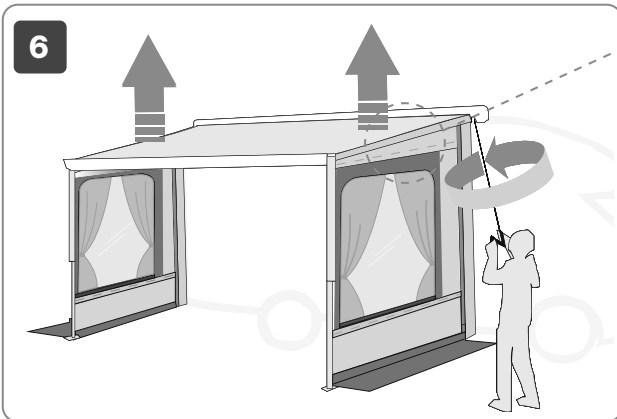
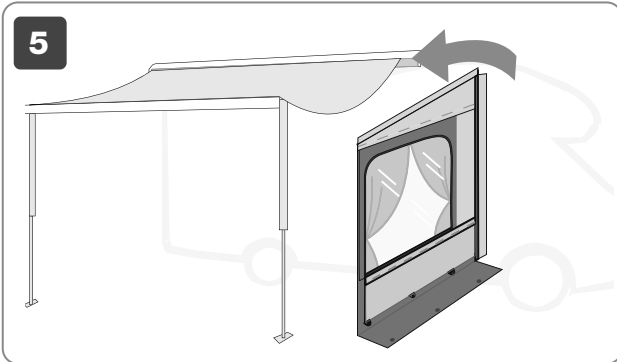
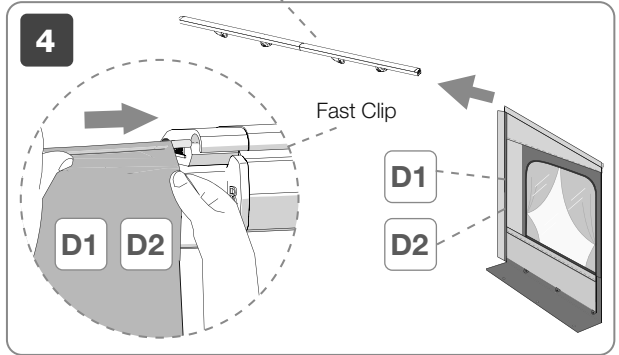
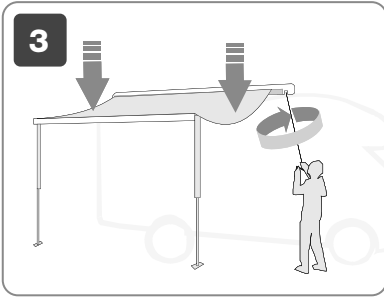



F65L

2



Fast Clip

G



F65

KIT 98655-899

X



Only for Privacy Room
320 Ducato
400 Ducato Kreos

K

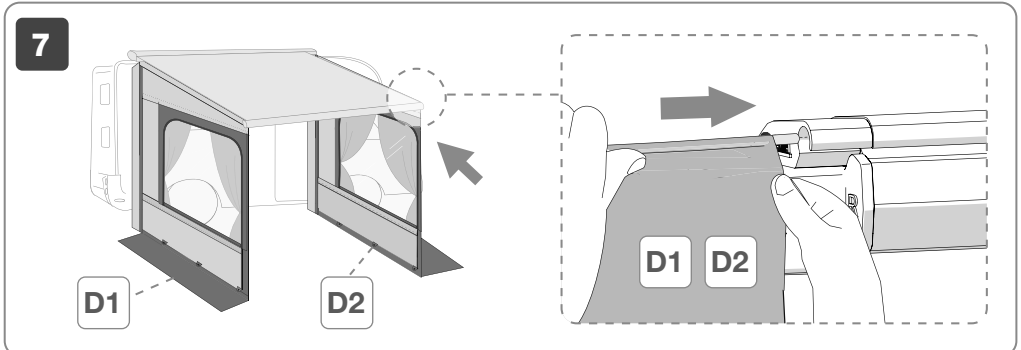
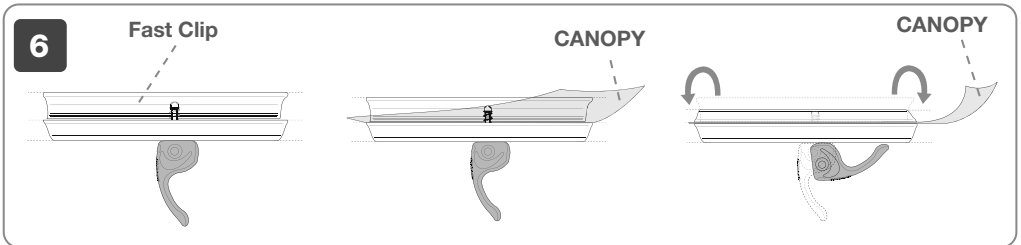
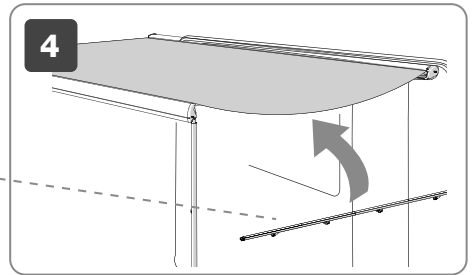
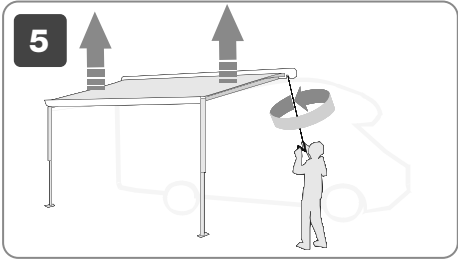
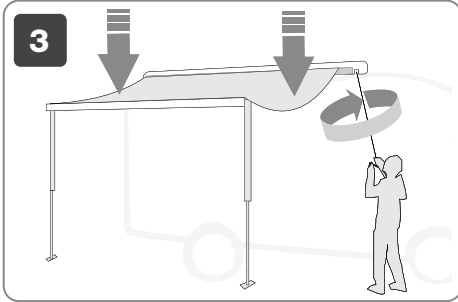

8

E Only for Privacy Room
400 Ducato Kreos

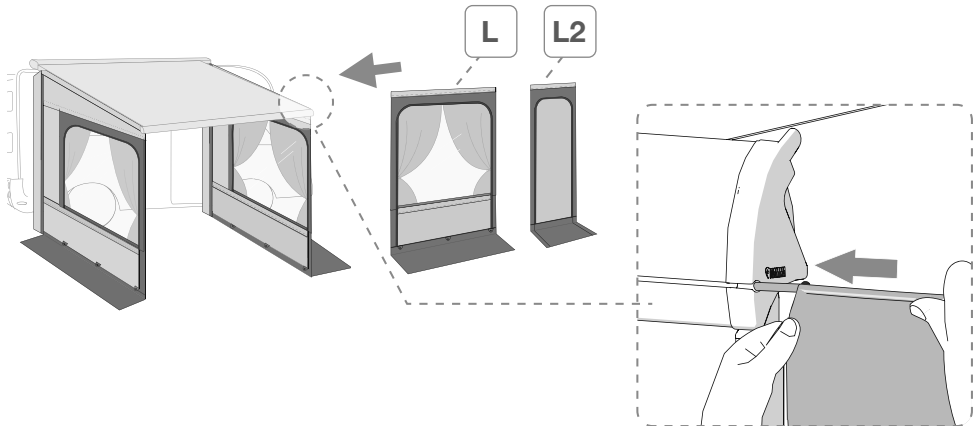
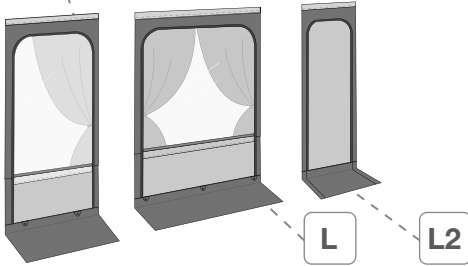

9

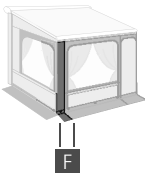
P.R. 320

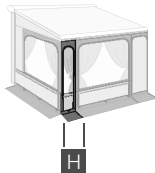

Front Panel 20
Item No. 08364-01-

P.R. 340

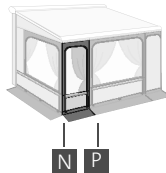

Front Panel 40
Item No. 08364A01-

 P.R. 370
P.R. 400

Front Panel 70
Item No. 08364C01-
Front Panel 100
Item No. 08364E01-

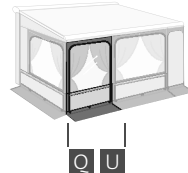
 P.R. 425
P.R. 450

Front Panel 125
Item No. 08364F01-
Front Panel 150
tem No. 08364H01-

10

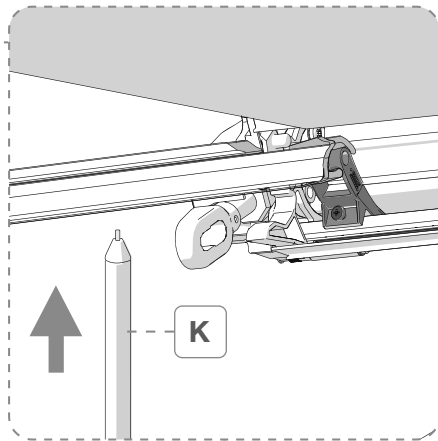
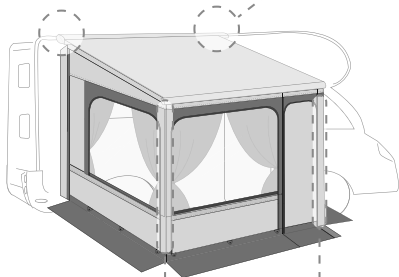

4x

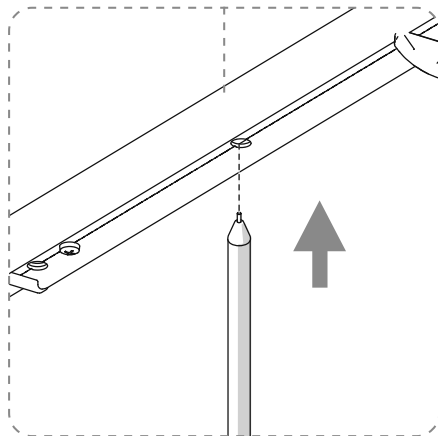
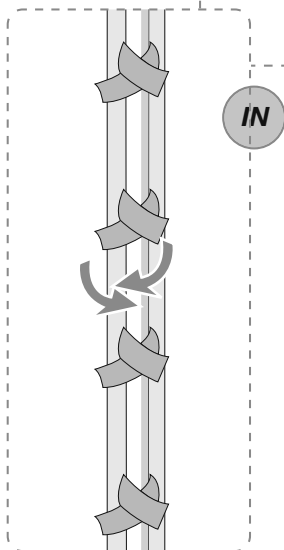

11

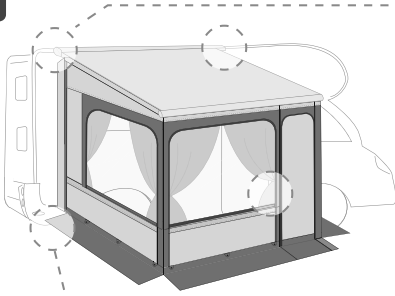

Not for: Privacy Room 400 Ducato Kreos
Privacy Room 300/245-280

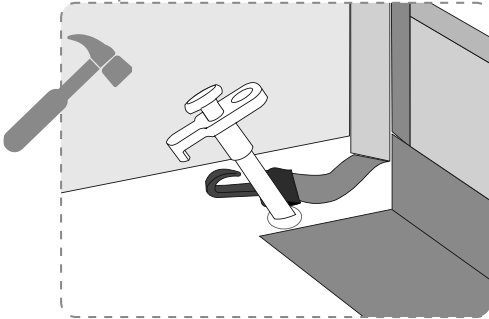
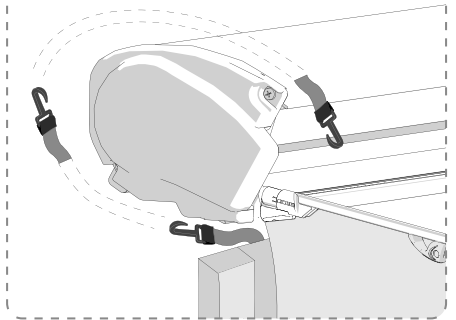

12

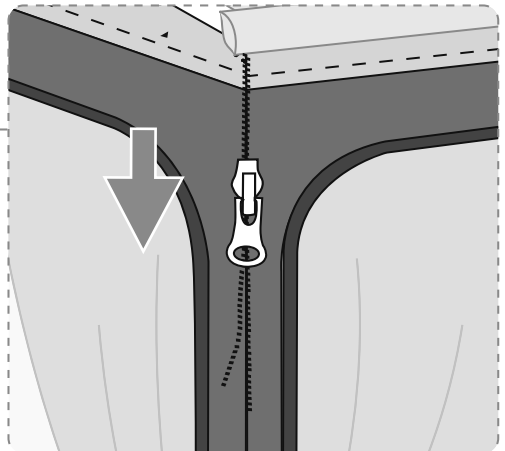
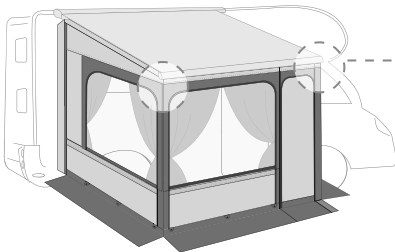



- EN** Before tapping, close the windows fastening them to the velcro at the bottom.
- DE** Schließen Sie die Fenster vor dem Abstecken, indem Sie sie unten am Klettverschluss befestigen.
- FR** Avant de planter les piquets, fermer et attacher les fenêtres à l'aide du velcro situé dans la partie inférieure.
- ES** Antes de montar, cerrar las ventanas sujetándolas al velcro en la parte inferior.
- IT** Prima di picchettare, chiudere le finestre fissandole al velcro nella parte inferiore.

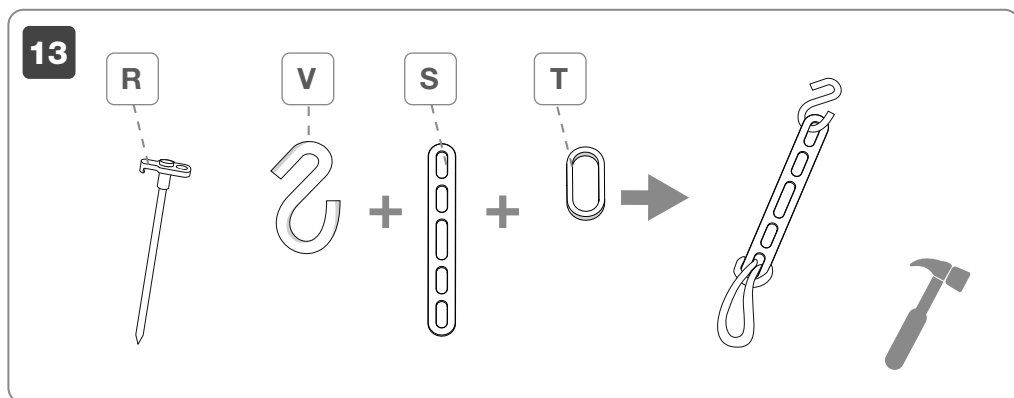

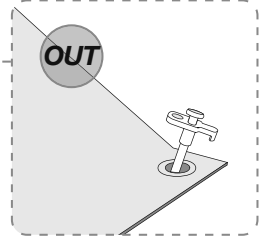
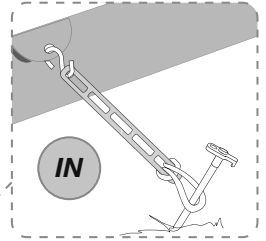
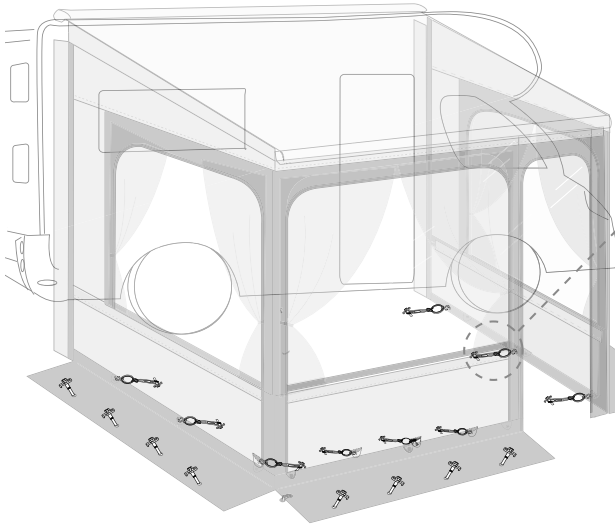
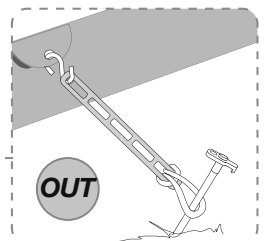
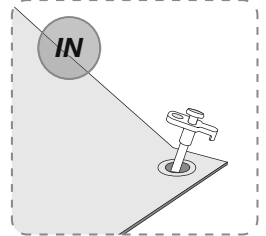
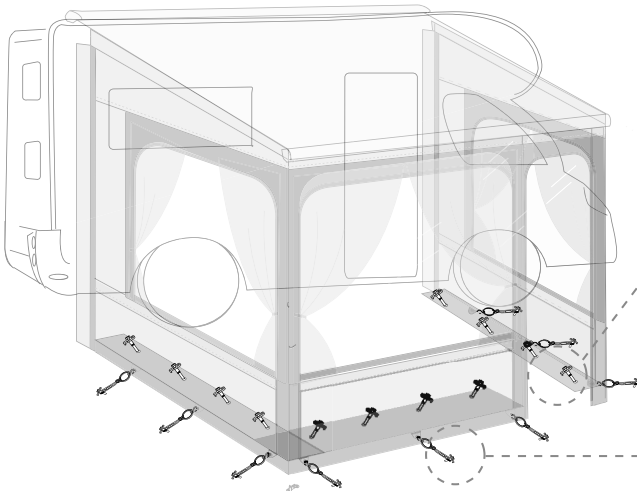
OPTION 1**OPTION 2**

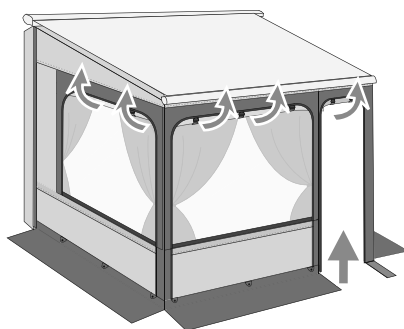
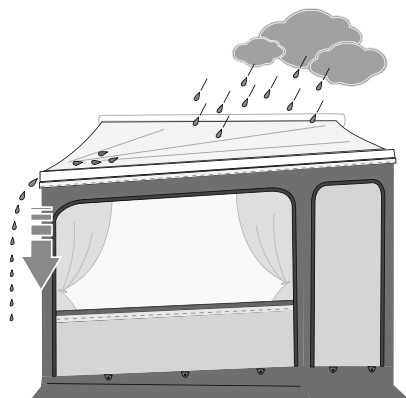

EN

In case of rain we recommend to lower a pole to allow the water to flow.

DE

Bei Regen ist es ratsam einen Stützfuß tiefer zu setzen, so dass ein Wasserabfluss ermöglicht wird.

FR

En cas de pluie, il est recommandé de baisser un pied du store pour que l'eau puisse s'écouler de l'autre côté.

ES

En caso de lluvia, es aconsejable bajar una pata para que el agua fluya.

IT

In caso di pioggia é consigliabile abbassare una palina per permettere all' acqua di defluire.

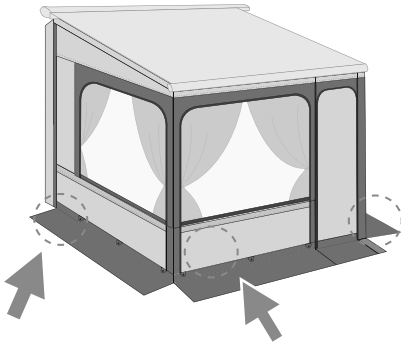

Item identification
Number



EN In case of problems please contact your local dealer indicating the data on the nameplate. Consult our website for spare parts drawing.

DE Bei Problemen bitte den Händler kontaktieren und die auf dem Etikett aufgeführten Daten mitteilen. Auf der Homepage finden Sie die Explosionszeichnung

FR En cas de problème, contacter le revendeur et lui communiquer les informations reportées sur la plaquette. Consulter le site Internet pour une vue éclatée des pièces de rechange.

ES En caso de cualquier problema, ponerse en contacto con su distribuidor local facilitando los datos sobre la placa. Consultar el sitio web para el despiece de los repuestos.

IT In caso di problemi contattare il rivenditore di zona, comunicando i dati riportati sulla targhetta. Consultare il sito web per l'esplosivo ricambi.





EN

Fiamma declines all responsibility for any personal injury and damage to property due to incorrect assembly or use of the product; it is suggested to keep the instructions inside the vehicle.

Keep the original packaging to be used in case of return. The assembly of the product must be carried out according to the assembly instructions: the product must not be modified in any way. All our privacy closures are made with an high quality standard. Apart from our strict quality controls, we also have our fabrics continuously controlled by independent institutes to ensure that the fabric is tear resistant, they can hold the weight of water, the colours don't fade and it is resistant against atmospheric agents. To guarantee a perfect quality, the fabrics are waxed or laminated several times.

During this operation, single coloured pigments could move and thus create small bright spots in the material, which are only irregularities that are technically inevitable to avoid, but do not compromise the impermeability of the fabric. Irregularities in weaving (such as knots and thickening) are due to unavoidable manufacturing tolerances and are not grounds for complaint; do not prejudice in any way the qualities of the Privacy. Especially with light fabrics, folds may form that backlight seems dark.

They are irregularities of technically unavoidable materials due to the specific workings.

MAINTENANCE INSTRUCTIONS

The formation of condensation water inside of the veranda is due to oscillations between external and internal temperature, it can be reduced by using an airtight floor and with good ventilation. Store the Privacy closure only if it is dry and possibly clean. The remaining humidity could cause stains. If you are forced to close it when it is still wet, after max. 12 hours reopen it to make it dry. Most of the dirt is superficial and can be removed with clean water and a cloth or a brush. If the fabric is very dirty, add some light cleaning detergent (Marseille soap). Any residual detergent on the fabric must be carefully rinsed. Be aware never to use any aggressive chemical substances and never to clean the fabric with a high pressure machine.

Windows in transparent PVC: don't use detergents which contain alcohol or solvents. Wash it only with hot water and soft cloth.

Zippers: Subjected to continuous stress and wear. Open and close gently and slowly without tearing, avoiding excessive effort during fixing to the ground. Keep them sliding using a normal zipper spray.

Curtains: Wash at 30 ° C with mild detergent. Accessories for curtains, hooks, eyelets and windscreens are items subject to wear. The duration depends on the stresses to which they are exposed.

DE

Fiamma lehnt jede Verantwortung für Personen- oder Sachschäden, die durch falsche Anbringung oder unsachgemäßen Gebrauch des Produktes verursacht wurden, ab. Es ist ratsam, die Anleitungen im Fahrzeuginneren aufzubewahren. Bewahren Sie die Originalverpackung für den Fall der Rücksendung auf. Das Produkt muss gemäß der Montageanleitung angebracht werden: das Produkt darf in keiner Weise verändert werden. Alle unsere Privacy Vorzelte werden nach einem hohen Qualitätsstandard hergestellt. Zusätzlich zu unseren strengen Qualitätskontrollen werden unsere Stoffe regelmäßig durch unabhängige Labors auf Reißfestigkeit, Wasserdruck, Lichtechtheit und Witterungsbeständigkeit geprüft. Um absolute Dichte zu gewährleisten, wird das Gewebe mehrfach beschichtet oder laminiert. Dabei können sich einzelne Farbpigmente versetzen und es entstehen sehr kleine Lichtflecken auf der Gewebeoberfläche, die nur, technisch unvermeidbare Unregelmäßigkeiten im Gewebe sind, welche die Wasserdichtigkeit des Gewebes in keiner Weise beeinträchtigen. Unregelmäßigkeiten im Gewebe (z.B. Knoten und Verdichtungen) sind aufgrund Fertigungstoleranzen unvermeidbar und stellen keinen Grund zur Beanstandung dar; sie beeinträchtigen in keiner Weise die Qualität des Privacy. Besonders bei hellen Stoffen können sich Falten bilden, die im Gegenlicht dunkel erscheinen. Dabei handelt es sich um Materialunregelmäßigkeiten, welche durch spezifische Verarbeitungsschritte bedingt und somit unvermeidbar sind. Witterungseinflüsse können im Laufe der Zeit zu Farbveränderungen führen.

PLEGE UND INSTANDHALTUNG

Die Bildung von Kondenswasser im Inneren des Vorzeltes ist ein Phänomen, das auf Schwankungen zwischen Außen- und Innentemperatur zurückzuführen ist, und kann durch die Verwendung eines hermetischen Fußbodens mit guter Belüftung reduziert werden. Verstauen Sie das Privacy nur, wenn es trocken und so sauber wie möglich ist. Restfeuchtigkeit kann Flecken verursachen. Wenn Sie dies dennoch feucht zusammenlegen und verstauen müssen, öffnen Sie dies nach maximal 12 Stunden damit es trocken kann. Der grösste Teil des Schmutzes ist oberflächlich und kann mit Wasser und einem sauberen Tuch oder einer Bürste entfernt werden. Wenn das Tuch stark verschmutzt ist, fügen Sie dem Wasser ein neutrales Reinigungsmittel hinzu (Marseille-Seife). Eventuelle Waschmittelrückstände auf dem Gewebe müssen gründlich abgespült werden. Verwenden Sie niemals aggressive Chemikalien oder Hochdruckreiniger. Transparente PVC Fenster: verwenden Sie keine alkohol- oder lösungsmittelhaltigen Reinigungsmittel.

Nur mit klarem Wasser und einem weichen Tuch waschen. Reißverschlüsse: unterliegen einer ständigen Beanspruchung und Abnutzung. Öffnen und Schließen Sie diese sanft und langsam, ohne zu reißen, und vermeiden Sie übermäßige Anstrengung bei der Befestigung am Boden. Mit einem normalen Reißverschluss-Spray lässt sich der Reißverschluss fließend öffnen und schließen. Vorhänge: mit delikatem Waschmittel bei 30° C reinigen. Spannzubehör, Haken, Ösen und winddichte Laschen unterliegen dem Verschleiß. Die Lebensdauer ist abhängig von den Beanspruchungen, denen sie ausgesetzt sind.



FR

Fiamma décline toute responsabilité en cas de dommages aux biens ou de lésions corporelles qui dériveraient d'un usage inapproprié de l'article. Conserver les notices à l'intérieur du véhicule. Conserver l'emballage original pour un éventuel retour. Respecter les consignes de montage contenues dans la notice; ne jamais apporter de modifications. Tous nos auvents Privacy sont réalisés dans le respect d'un standard de qualité élevé. Outre nos contrôles de qualité très rigoureux, nous faisons régulièrement analyser nos tissus par des laboratoires indépendants afin de nous assurer de la bonne résistance aux déchirures, à la pression de l'eau, et pour garantir la tenue des couleurs et la résistance aux intempéries. Pour garantir une tenue absolue, les tissus sont enduits et laminés plusieurs fois. Durant cette opération, des pigments colorés peuvent se déplacer et créer sur la surface du tissu des petits points lumineux, qui sont de simples irrégularités du tissu techniquement inévitables mais qui ne compromettent en rien l'imperméabilité du tissu. Des irrégularités au niveau du tissu (comme des nœuds ou des épaisseurs différentes) sont inévitables et dues au processus de fabrication; elles ne constituent pas un motif de réclamation puisqu'elles n'affectent aucunement la qualité du Privacy. Spécialement pour les tissus clairs, des plis sont susceptibles de se former et d'apparaître plus sombres à contre-jour. Il s'agit d'irrégularités des matériaux techniquement inévitables et dues aux processus spécifiques de conception. Au fil du temps, les agents atmosphériques sont susceptibles de provoquer des changements de couleur.

SOIN ET ENTRETIEN

La présence de condensation à l'intérieur de l'auvent est due à une différence de température entre l'intérieur et l'extérieur. La buée peut être réduite grâce à un sol plus hermétique et une bonne ventilation. Ranger l'auvent Privacy seulement s'il est sec et, si possible, propre. L'humidité restante peut provoquer des taches. Si l'auvent devait être replié encore humide, il est nécessaire de le « rouvrir » pour le faire sécher avant 12h au maximum. La saleté est généralement superficielle et peut être éliminée à l'eau à l'aide d'un chiffon ou d'une brosse. Quand le tissu est très sale, ajoutez à l'eau un détergent neutre (savon de Marseille). Rincer soigneusement les éventuels résidus de détergent présents sur le tissu. N'utilisez jamais de produits chimiques agressifs ni d'appareils à haute pression pour le nettoyage. Fenêtres en PVC transparent : Utiliser des détergents sans alcool ni solvant. Procéder au lavage à l'eau claire à l'aide d'un chiffon doux. Fermetures Éclair : au fil des utilisations et du temps, elles sont susceptibles de s'user. Les ouvrir et les fermer délicatement et lentement sans tirer dessus, évitant ainsi d'exercer une pression excessive durant les opérations de fixation au sol. Les entretenir à l'aide d'un spray lubrifiant pour fermetures Éclair. Rideaux : Lavage à 30° C avec lessive pour linge délicat. Accessoires de mise en tension, crochets et œilletons sont sujets à une usure normale. Leur durée de vie dépendra des sollicitations auxquelles ils seront soumis.

ES

Fiamma declina toda responsabilidad por cualquier lesión personal y daño a la propiedad causado por al montaje o el uso incorrecto del producto; se sugiere mantener las instrucciones dentro del vehículo. Se recomienda guardar el embalaje original para que esté disponible en caso de devolución. El montaje del producto debe llevarse a cabo según las instrucciones de montaje: el producto no debe modificarse de ninguna manera. Todos nuestros cierres Privacy se producen con un alto estándar de calidad. Tras de pasar nuestros severos controles de calidad, nuestras lonas vienen controladas por institutos independientes para garantizar una tela completamente estanca a los desgarros, a la presión del agua, tienen colores duraderos, resistentes a la luz y al lavado. Para garantizar un producto resistente, las telas vienen laminadas o untadas más veces. Durante esta operación los singulos pigmentos colorados pueden desplazarse y esto crea muy pequeños puntos luminosos, que son sólo irregularidades de los tejidos tecnicamente inevitables y que no comprometen la impermeabilidad de la lona. Las irregularidades en el tejido (como nudos y engrosamientos) se deben a tolerancias de fabricación inevitables y no son motivo de queja; no perjudican de ninguna manera la calidad del Privacy. Especialmente en lonas claras, pueden formarse arrugas que contraluz parecen oscuras. Son irregularidades de material técnicamente inevitables. Los agentes atmosféricos pueden causar cambios de color con el tiempo.

INSTRUCCIONES PARA LA CURA Y EL MANTENIMIENTO

La formación de agua de condensación dentro del toldo es un fenómeno debido a las oscilaciones entre la temperatura externa e interna, puede reducirse utilizando un piso hermético y con buena ventilación. Guardar el cierre Privacy solo si está seco y posiblemente limpio. La humedad residual puede causar manchas. Si aún se ve obligado a cerrarlo mojado, después de 12 horas como máximo, volver a abrirlo para que se seque. La mayor parte de la suciedad es superficial y se puede eliminar con agua, un estropajo o un cepillo. Si la lona tuviese que ser demasiado sucia, añadir un detergente delicado al agua. Cualquier detergente residual en el tejido debe enjuagarse cuidadosamente. No use sustancias químicas agresivas y no use nunca un aparato para la limpieza de alta presión. Ventanas de PVC transparente: no usar detergentes que contengan alcohol o solventes. Lavar solo con agua limpia y un paño suave. Cremalleras: sujetas al estrés continuo, pueden desgastarse. Abrirlas y cerrarlas suavemente y despacio sin romperlas, evitando tensiones excesivas durante el anclaje a tierra. Usar un spray para mantener las cremalleras deslizantes. Cortinas: lavar a 30 ° C con un detergente suave. Los accesorios para cortinas, ganchos, ojete y pestañas cortavientos son artículos sujetos a desgaste. La duración depende de las tensiones a las que están expuestos.



Fiamma declina ogni responsabilità per eventuali lesioni personali e danni alle cose dovute al montaggio oppure all'uso errato del prodotto; si suggerisce di custodire le istruzioni all'interno del veicolo. Conservare l'imballo originale da utilizzare in caso di reso. Il montaggio del prodotto deve essere eseguito rispettando le istruzioni di montaggio: il prodotto non deve essere modificato in alcun modo. Tutte le nostre chiusure Privacy sono prodotte con uno standard qualitativo elevato. Oltre ai nostri severi controlli della qualità, facciamo verificare periodicamente i nostri tessuti da laboratori indipendenti per accertarne la resistenza allo strappo, alla pressione dell'acqua, alla solidità della luce ed alla resistenza agli agenti atmosferici. Per garantire una tenuta assoluta, i tessuti vengono spalmati o laminati più volte. Durante questa operazione, singoli pigmenti colorati possono spostarsi e ciò crea sulla superficie dei tessuti piccolissimi punti luminosi, che sono solo irregolarità dei tessuti tecnicamente inevitabili e che non compromettono minimamente l'impermeabilità del tessuto. Irregolarità nella tessitura (come nodi e ispessimenti) sono dovute a tolleranze di fabbricazione inevitabili e non sono motivo di reclamo; non pregiudicano in alcun modo le qualità della Privacy. Specialmente con i tessuti chiari, possono formarsi pieghe che in controluce sembrano scure. Sono irregolarità dei materiali tecnicamente inevitabili dovute alle specifiche lavorazioni. Gli agenti atmosferici possono nel tempo provocare cambiamenti di colore.

CURA E MANUTENZIONE

La formazione di acqua di condensa all'interno della veranda è un fenomeno dovuto a oscillazioni fra temperatura esterna ed interna, può essere ridotta utilizzando un pavimento ermetico e con una buona ventilazione. Riporre la chiusura Privacy solo se è asciutta e possibilmente pulita. L'umidità residua può provocare macchie. Se si è comunque costretti a richiuderla ancora umida, dopo 12 ore al massimo "riapirla" per farla asciugare. La maggior parte dello sporco è superficiale e si può eliminare con acqua ed un panno pulito o una spazzola. Se il tessuto dovesse essere molto sporco, aggiungere un detersivo neutro all'acqua (sapone di Marsiglia). Eventuali residui di detersivo sul tessuto devono essere accuratamente risciacquati. Non utilizzare mai sostanze chimiche aggressive o apparecchi per la pulizia ad alta pressione.

Finestre in PVC trasparente: non usare detersivi contenenti alcol o solventi. Lavare solo con acqua pulita e un panno morbido.

Chiusure lampo: Sottoposte a continue sollecitazioni, sono soggette ad usura. Aprire e chiudere delicatamente e lentamente senza strappare, evitando uno sforzo eccessivo durante il fissaggio a terra. Mantenere scorrevoli utilizzando un normale spray per chiusure lampo. Tendine: Lavare a 30° C con detersivo delicato. Accessori per tendere, ganci, occhielli e linguette antiventone sono articoli soggetti ad usura. La durata dipende dalle sollecitazioni a cui essi sono esposti.



P.R. 320

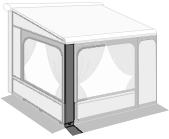

Front Panel 20
Item No. 08364-01-

P.R. 340

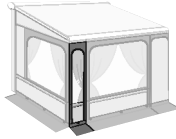

Front Panel 40
Item No. 08364A01-

P.R. 370
P.R. 400

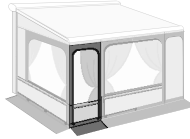

Front Panel 70
Item No. 08364C01-
Front Panel 100
Item No. 08364E01-

P.R. 425
P.R. 450

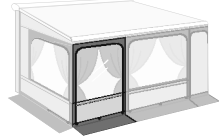

Front Panel 125
Item No. 08364F01-
Front Panel 150
Item No. 08364H01-

Tie Down S

Item No. 98655-567
Item No. 98655-133

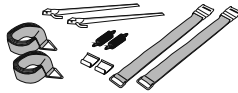

Door Pole (only for F65)

Item No. 05161-08-

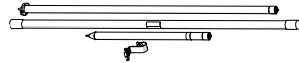

Privacy Kit Rail

Item No. 07364-01-

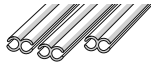

Curtains Kit Dark Grey

Item No. 08671-01- (2 pcs.)
Item No. 08671A01- (6 pcs.)



Pack Organizer

Item No. 07512A01-
Item No. 07512-01-
Item No. 07513-01-

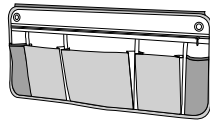

Pack Organizer Privacy

Item No. 07366-01-

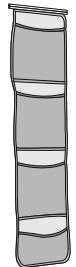

Kit Magic Privacy Front Short for awning from 260 to 375

Item No. 06856-01-

Kit Magic Privacy Front Medium for awning from 400 to 450

Item No. 06856-01-

Kit Magic Privacy Side

Item No. 06856-04-

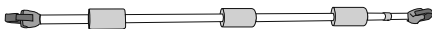

Skirting Ducato

Item No. 06469-01-

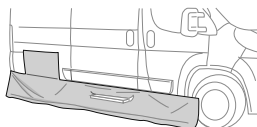

Skirting Caravan

Item No. 98655-084

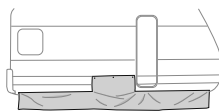

Skirting Motorhome

Item No. 98655-090

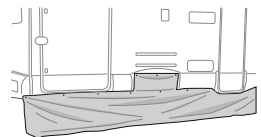



EN

Warranty Fiamma

In case of defects with regards to materials and manufacturing, the customer is entitled to the warranty in accordance with local laws and regulations of the country in which the product was purchased.

DE

Garantie Fiamma

Im Falle einer Mangelhaftigkeit der Ware, kann der Verbraucher unter den erforderlichen Voraussetzungen gegenüber dem Verkäufer von dem Garantieanspruch zu den festgelegten Bedingungen gemäss den lokalen Rechtsvorschriften Gebrauch machen.

FR

Garantie Fiamma

En cas d'un défaut de conformité du produit, le consommateur pourra faire valoir ses droits de recours en garantie selon les modalités prévues par les dispositions légales locales, pour autant que les conditions de recours soient satisfaites.

ES

Garantía Fiamma

En caso de fallos o defectos de material y de fabricación, el cliente puede hacer valer la garantía de acuerdo con las leyes y reglamentaciones del país en el que el producto haya sido comprado.

IT

Garanzia Fiamma

In caso di difetto di conformità dei beni, il consumatore potrà far valere nei confronti del venditore la garanzia secondo le modalità previste dalle disposizioni di legge locali, ove ne ricorrano i presupposti.

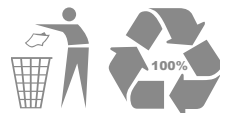



GO_IS_98691-052_revD

Privacy Room F65



Fiamma S.p.A. - Italy

Via San Rocco, 56

21010 Cardano al Campo (VA)

fiamma.com

All rights reserved.

Fiamma S.p.A.

reserves the right to modify at any time,
without notice, prices, materials,
specifications and models or to cease
production of any model.